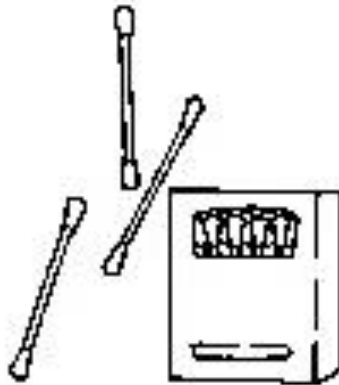
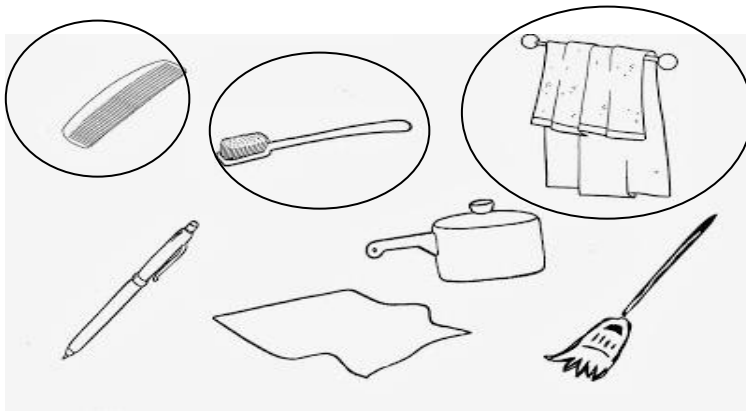

**COLÉGIO MARQUES RODRIGUES**Estrada da Água Branca, 2551 – Realengo – RJ  
Tel: (21) 3462-7520 – www.colegiomr.com.br**Questão 1:**

Para sermos saudáveis, devemos cuidar de nossa corpo. Faça um **X** na atitude que devemos ter antes das refeições.

**Questão 2:**

Pinte o que devemos usar para cuidarmos da nossa higiene das orelhas.

**Questão 3:****Questão 4:**

F / V / F

**Questão 5:**

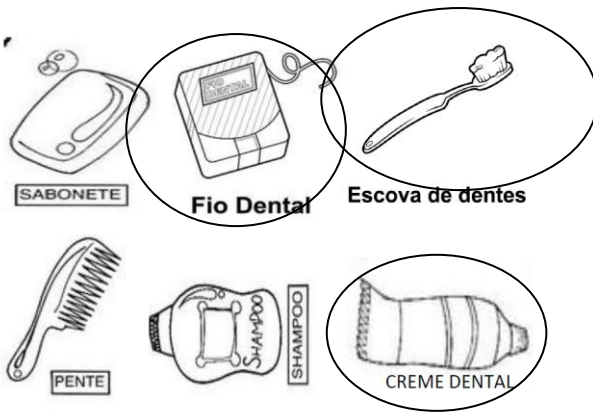

**Questão 6:**

Ficam cariadas.

**Questão 7:**

Qual é a função dos dentes? Trace as respostas.

Cortar os alimentos

Triturar os alimentos.

**Questão 8:**

sim

**Questão 9:**

mãe

**Questão 10:**

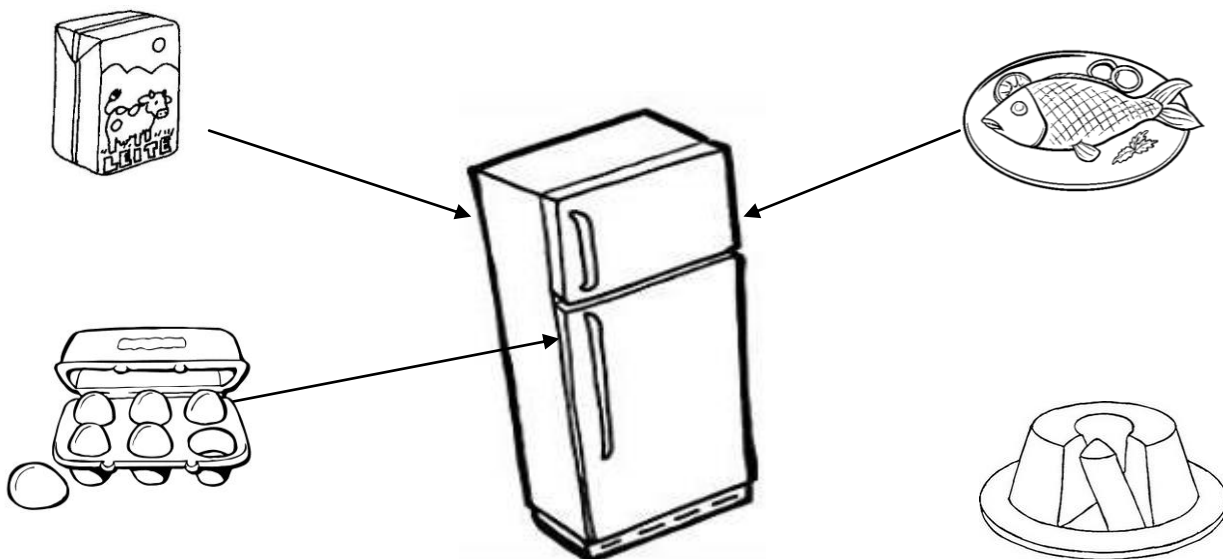

**Questão 11:**

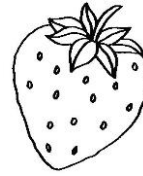
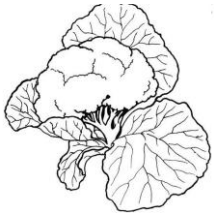

**Questão 12:**

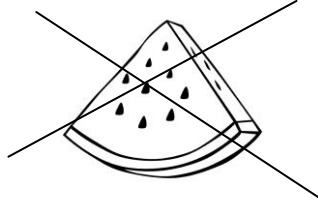
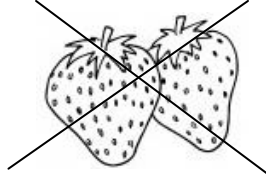
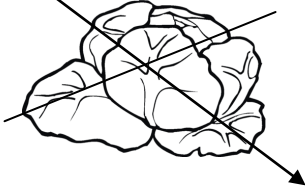

**Questão 13:**

Associe os nomes das frutas na cruzadinha.

**Questão 14:**

Eu como maçã todo dia.

Meu pai come abacaxi e mamãe abacate.

Meu tio adora comer salada de legumes.

**Questão 15:**

Quais objetos abaixo são feitos de madeira? Responda pintado.

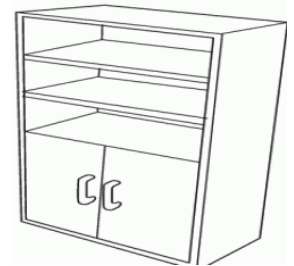
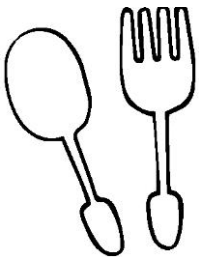

**Questão 16:**

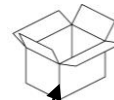

plástico

madeira

vidro

papel

metal

**Questão 17:**

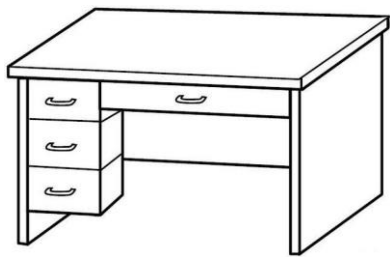

**Questão 18:**

O aluno deve pintar o mosquito e depois fazer um desenho em cima da caixa de água

**Questão 19:**

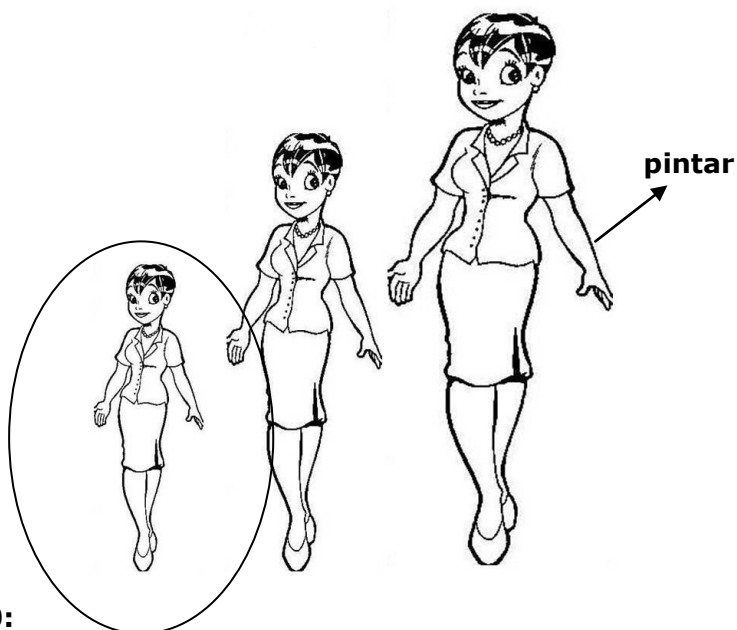

**Questão 20:**

